

## DCP100 DIGITAL CONTROL PROGRAMMER

EN01-6028 10/96

PRODUCT SPECIFICATION SHEET

### OVERVIEW

The DCP100 is a microprocessor based 1/4 DIN programmer/controller for process variable versus time control of temperature, humidity, flow, pressure and other variables. Designed to meet a wide range of application needs, the DCP100 provides 0.25% accuracy, up to 7 digital outputs for event and time sequencing and 6 digital inputs for remote program selection and operation. Set up and operation is quick and easy with the specifically designed dedicated man-machine interface.

The DCP100 can store up to 8 programs, each of which can include up to 16 segments. You can join programs together and build profiles for complex applications. (up to 121 consecutive segments total).

### FEATURES

#### High functionality at low cost

The DCP100 combines state-of-the-art technology at a very competitive price.

#### Easy to use

Three large displays and user friendly keys make the DCP 100 easy to use. The message display guides you through the setup, configuration and operation.

#### Profile capability

The DCP 100 can store up to 8 programs with 16 segments per program. These 128 segments can be configured as ramps, soaks, end of program or join to another program.

To meet sophisticated profiling needs, «cycling», and «program link» feature are available. «Cycling» consists of repeating the whole program. The «program link» feature offers the possibility to link several programs and get a longer sequence.

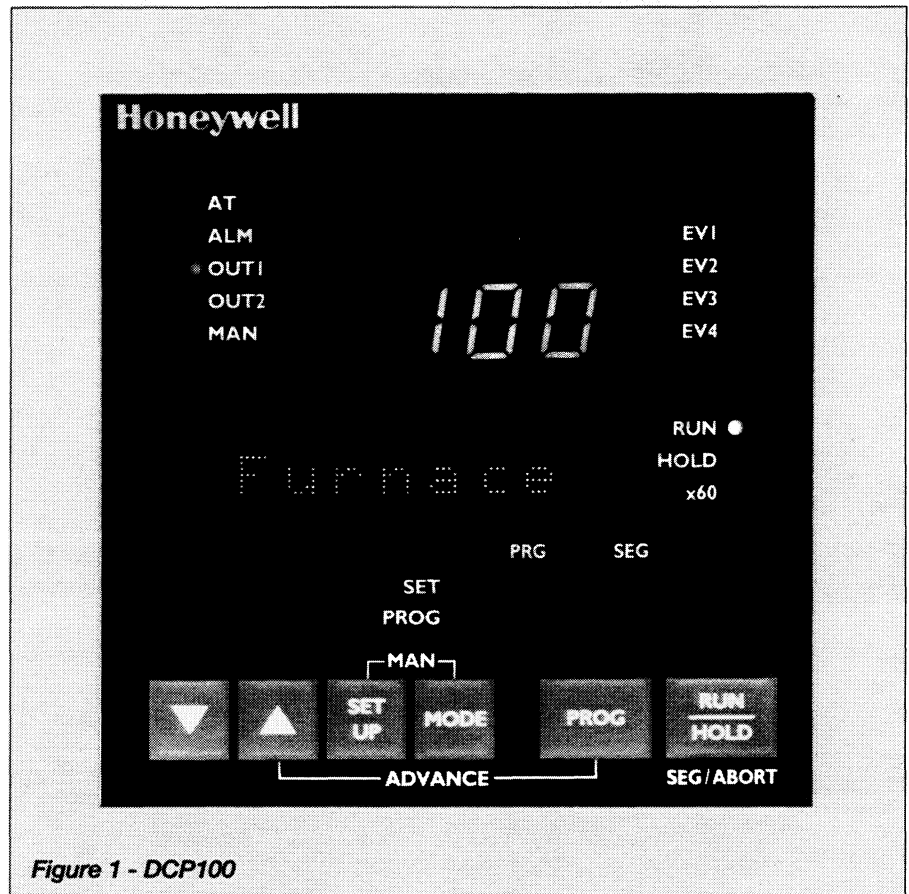

Figure 1 - DCP100

#### Guaranteed soak

The guaranteed soak facility ensures that your soak is completed over the timing you had specified. This function is also applicable on ramp or on both ramp and soak. You can define a band above and/or below the setpoint that will hold the program when the PV is outside of the band.

#### PV START

This function offers the possibility to define setpoint values at start of each program. It could be either the current controller setpoint value (LSP) or the current process variable value (PV).

#### Power failure recovery

For critical application, the DCP100 allows you to select the response after a power failure. The restoration mode

could be either a cold start (return to Local Setpoint) or a hot start (resume from the point where power failed).

#### PC Configuration and profile editor

Software has been developed to configure the DCP100 through its internal communication port. Through the profile editor, you can simply draw profiles, you can save them in your PC, and you can download them to the DCP. Any programs can be labeled and the name will be displayed in the front of the DCP (message display).

#### Real Time Clock

Any program can start at a certain predetermined time on a certain day of the week.

## OPTIONAL FEATURES

The following can be selected via the model selection guide (see page 9).

- Output 2 (Relay, SSR driver, linear)
- Output 3 (Relay, SSR driver, linear)
- RS485 ASCII Communication
- Low voltage power supply (24 to 48 Vac/dc)
- Events outputs (4 relays)
- Remote program control (6 dry contact inputs)
- Real Time Clock

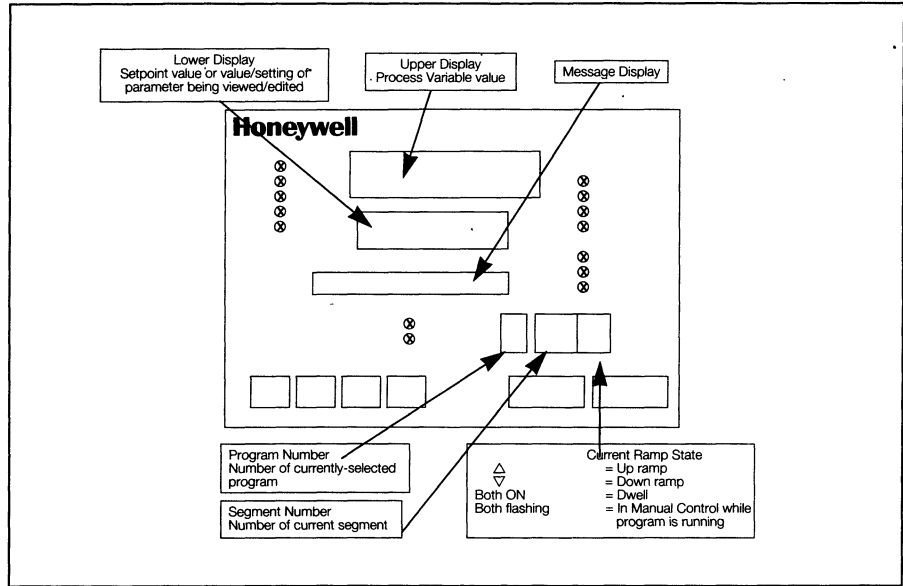

### Operator Interface (LED)

- ❖ AT
- ❖ ALM
- ❖ OUT 1
- ❖ OUT 2
- ❖ MAN

#### Control Status Indicators

- AT - ON when Self-Tune is active; flashes when Pre-Tune is active.
- ALM - Flashes when any alarm is active.
- OUT1 - ON when primary control output is active.
- OUT2 - ON when secondary control output (if fitted) is active.
- MAN - ON when Manual Control is selected.

- RUN ❖
- HOLD ❖
- x60 ❖

#### Run Status Indicators

- RUN : ON - Program running or (If HLD ON also) held - Flashing - Program in Delayed state
- HLD : ON - Program held - Flashing - Program in Auto-Hold
- x60 : OFF - timebase = hours/minutes - ON - timebase = minutes/seconds

- EV1 ❖
- EV2 ❖
- EV3 ❖
- EV4 ❖

#### Event Indicators

Each indicates the status (active or inactive) of a user-defined event (OFF = inactive, ON = active).

- SET ❖
- PRG ❖

#### Mode Indicators

- SET - ON when Controller Define Mode or Program Define Mode is entered; flashes when viewing parameters in Controller Define Mode or Program Define Mode after entry from Base Mode.
- PRG - ON when Program Define Mode is entered.

## Key functions

**MODE**

**MODE Key**

Changes mode of instrument

**PROG**

**Program Key**

Cycles through Program Numbers

**SET  
UP**

**Set Up Key**

Displays the next parameters in sequence  
(indicated by Message display)

**RUN  
HOLD**

**Run/Hold Key**

Runs, holds or aborts current program



**Down Key**

Decrements displayed parameter  
value/cycles through options



**Up Key**

Increments displayed parameter  
value/cycles through options



**+**

**MODE**

Selects/de-selects Self-Tune and  
Pre-Tune (when Message Display shows  
appropriate message)



**+**

**PROG**

Jumps to next segment, when a  
program is running

**SET  
UP**

**+**

**MODE**

Selects/de-selects Manual Control



**+**



Sets a segment to soak when  
defining a program

## PHYSICAL DESCRIPTION

The DCP100 is a 1/4 DIN (96 x 96 mm) programmer/controller housed in a 100 mm (4.33 inches) deep case. By using the mounting bracket that comes with the unit, you can easily install the programmer into a 1/4 DIN panel cutout. The modular plug-in construction allows easy upgradability, rapid access and saves time. All inputs and outputs are connected on the terminal block with screws.

## UNIVERSAL INPUT

Accepts several types of thermocouples, RTD's, current and linear voltage inputs. All inputs are configurable through keyboard and jumper selections. A configurable digital filter is available from 0.5 s. to 100.0 sec.

## UNIVERSAL POWER SUPPLY

The DCP100 can operate at any line voltage from 90 Vac to 264 V ac at 50/60 Hz continuously. A 24/48 Vac/dc model is also available as an option.

## OUTPUT ALGORITHMS

The DCP100 is available with the following output algorithms :

- Time proportional ON/OFF or time proportional with electromechanical Relay SPDT 2A or SSR driver (open collector)
- Current proportional : Supply directly proportional current or volt signal to the final control elements which require 0-10 V, 0-5 V or 4-20ma, 0-20mA.
- Time Proportional Duplex : Two different modes can be selected, either ON-OFF duplex or time proportional duplex (heat/cool with 2 proportional bands), two cycle times and dead band.
- Current proportional duplex : In addition to the first current/volt

output, provides a second similar output with its own proportional band.

- Current /Time or Time/Current Duplex provides a variation of traditional time or current duplex mode by mixing current and time proportioning together.
- Control algorithm : Three control algorithms can be set up through the configuration menu :  
 ON-OFF  PID  PD + MR

## ALARMS

Outputs 2 and 3 can be used as alarms. Two electromechanical single pole double throw relays can activate external equipment when alarm setpoints are reached. An LED is also activated on the front face. A direct or reverse acting alarm output can be configured. In order to detect a defective control loop, the programmer controller can apply a special loop alarm or heater break alarm by continually monitoring the PV response to output demand. A timer is automatically set when any output is in saturation mode. For PID control, when the timer reaches twice the reset time with no change in PV, the alarm is activated. For ON/OFF control, the loop alarm time is user-definable. This heater break alarm saves wiring, time and cost. A specific relay is provided (standard) to indicate the end of program.

## DIGITAL INPUTS

(optional board)

Six Digital inputs dry contact provide facilities for remote program selection and Run/Hold/Abort/x60 operation.

## DIGITAL OUTPUTS

(optional board)

In addition to the 2 Alarm Relays assigned to the PV, deviation and band alarms, the DCP 100 offers 4 additional event outputs relative to the time scale. The state of each event output can be user-defined for each segment.

## COMMUNICATION

(optional board)

The DCP100 can be equipped with a serial ASCII communication interface. The selectable rate are 1200, 2400, 4800 or 9600 baud. A specific master communication mode can be selected in order to automatically send the current program setpoint to each (up to 32) slave instruments (like the UDC1000/1500 or DCP100 in slave mode). The Master unit will detect all connected slave instruments and will automatically skip addresses with no instrument connected. This specific Master/Slave communication mode updates all setpoint devices 10 times per second at 9600 baud or 5 times per second at 4800 baud.

## SPECIFICATIONS

### Technical Data

<b>Program facility</b>	N° of programs	8 programs cascadable
	N° of segments	16 segments per program
	Total N° of segments	128 segments free format (max. length : 121 segments)
	Segment type	RAMP, SOAK, JOIN, REPEAT and END
	Program cycling	1 to 9999
	Delayed start	0 to 99:59 (hours:minutes)
	Segment time	0 to 99:59 (hours : minutes or minutes : seconds)
	Ramp rate	1 to 9999 per hour or per minute
	Guaranteed SOAK	OFF, below or above setpoint both applicable on SOAK, RAMP or both from 1 to input span
	START Mode	From current process variable or controller Set point value
	END Mode	To final programmer setpoint or controller setpoint
	Control Mode	RUN, HOLD, ABORT, X60 (local or remote) Select program (local or remote) Jump to next segment
	<b>Input</b>	Accuracy
T° Stability		0.01% of span per °C
Sampling Rate		Four samples per second
Input Filter		Digital filter configurable from front panel. 0.0(OFF), from 0.5 s to 100.0 seconds in 0.5 s increment
Input Resolution		14 bits approximately; always four times better than display resolution
Input Isolation		Universal input isolated at 2500 V from all outputs except SSR and from power supply
Input Signal Failure		- For thermocouple, detected by any lead break within 2 seconds control output set to OFF (0%), upscale burnout - For RTD, detected by any lead break within 2 seconds control output set to OFF (0%), downscale burnout - For DC linear : 4-20 mA, 1-5 V and 2-10 V only detected within 2 seconds control output set to OFF (0%), downscale burnout
Input impedance		Volt : 47 Kohms Current : 4.7 ohms Others : 100 Mohms
<b>Stray rejection</b>	Common Mode	> 120 dB at 50/60 Hz giving negligible effect at up to 264 Vac 50/60 Hz
	Serial Mode	> 500 % of Span (at 50/60 Hz) causes negligible effect
<b>Control</b>	Output type	<i>Type available :</i> Output 1 : DC, Electromechanical relay, SSR drive (open collector) Output 2 : DC, Electromechanical relay, SSR drive (open collector) Output 3 : DC (transmission output only), Electromechanical relay, SSR drive (open collector) <i>DC output :</i> 4-20 mA Accuracy : $\pm$ 0.5 % (250 ohms for mA, 2 kohms for Volt) Resolution : 8 bits in 250 ms (10 bits in 1 second typical > 10 bits in >1 second) Load impedance : 500 ohms max. for current output Isolation : isolated 2500 V from all other inputs and outputs Range selection method : jumper positioning and front panel code setting Temperature stability : 0.01% / °C

**Technical Data (continued)**

<b>Control</b>	Output types	<i>Electromechanical relay</i> : SPDT contact Resistive load : 2 A at 120 V or 240 V Life time : > 500000 operations at rated voltage / current SSR drive/TTL : Drive capability : SSR > 4.3 V dc into 250 ohms min. Isolation : not isolated from input and other SSR output
	Output algorithm	Automatic tuning type : Pre-tune & self-tune Proportional bands : 0 (inactive), 0.5% to 999.9% of input span with 0.1% increments. Two proportional bands available for duplex mode. Reset : Off or from 1s to 99 min.59s Rate : From 0 to 99 min.59s Manual reset : from 0 to 100% of output (single output), from -100% to 100% of output (dual output) Deadband : $\pm 20\%$ of PB1+PB2 ON/OFF hysteresis : 0.1% to 10.0% of input span Auto/Manual mode : User selectable with bumpless transfer between automatic and manual mode Cycle times : Up to two cycle times available for time duplex control Selection : 0.5, 1, 2, 4, 8, 16, 32, 64, 128, 256 or 512 seconds
<b>Remote program control</b>	N° of Input	6 contacts voltage free or TTL compatible
	Program selection	3 contacts binary coded (2 <sup>0</sup> , 2 <sup>1</sup> , 2 <sup>2</sup> )
	Program control	3 contacts RUN/HOLD, x60, ABORT
<b>Time Event Output</b>	N° of Output	4 relays (SPDT) 5A resistive load (120/240 Vac)
	Triggering cause	Time EVENT programmable to either OFF or ON for each segment
<b>End of program</b>	Output type	1 relay SPDT 5A resistive load (120/240 Vac)
<b>ALARM Control</b>	N° of Alarms	2 soft Alarms setpoint + 1 Loop alarm
	Output type	Up to two relays or SSR output on output 2 and 3
	Alarm type	PV high or low, band, deviation high or low, loop
	Combination	Logical "OR" or "AND" of alarms to an individual hardware
<b>Retransmission</b>	Output type	Current or Volt output of output 3 can be selected to retransmit the process variable or setpoint
<b>Communication</b>	Protocol	RS485 ASCII Half Duplex
	Baud rate	1200, 2400, 4800, 9600, Bauds.
	Link characteristics	32 drop maximum (2 wires)
	Data format	Even parity, seven data bits and 1 stop bit
	Mode	Slave or Master
<b>Physical</b>	Dimension	Depth : 100 mm/3.94 inches Height : 96 mm/3.78 inches Width : 96 mm/3.78 inches
	Weight	210 grams max.
	Cut out	92 x 92 mm/3.62 x 3.62 inches Plug in with panel mounting fixing strap
	Terminals	Screw type (combination head)
	<b>Front Panel</b>	Sealing
<b>Power</b>	Type	90-264 Vac 50/60 Hz 20-50 Vac 50/60 Hz or 22-65 Vdc (option)
	Consumption	4 Watts
<b>Environmental</b>	EMI Susceptibility	Designed to meet EN50082-1 : 1992 and EN50082-2 : 1995
	EMI Emissions	Designed to meet EN50081-1 : 1992 and EN50081-2 : 1994
	Safety	Designed to comply with EN61010-1 : 1993
<b>Approval</b>	Europe	CE Mark- Conformity with 72/23/EEC / Low voltage directive Conformity with 89/336/EEC / EMC directive

## Input Actuators

		Ranges	
		°F	°C
<b>Thermocouple types</b> (Fixed decimal)	R	32 - 3002	0 - 1650
	S	32 - 3000	0 - 1649
	J	32.0 - 401.7	0.0 - 205.4
	J	32 - 842	0 - 450
	J	32 - 1401	0 - 761
	T	-328 - 503	-200 - 262
	T	32 - 501.0	0.0 - 260.6
	K	-328 - 1399	-200 - 760
	K	-328 - 2503	-200 - 1373
	L	32 - 402.2	0.0 - 205.7
	L	32 - 841	0 - 450
	L	32 - 1403	0 - 762
	B	211 - 3315	100 - 1824
	N	32 - 2550	0 - 1399
<b>RTD : (3 wires connection)</b> PT100 (IEC) (= 0.00385) (Fixed decimal)		32 - 1471	0 - 800
		32 - 571	0 - 300
		-149.7 - 211.9	-100.9 - 100.00
		32 - 213.6	0.0 - 100.9
		-328 - 402	-200 - 206
		-149.7 - 999.1	-100.9 - 537.3
<b>DC linear :</b> (Decimal point location configurable up to three places)		10 - 50 mV	0 - 50 mV
		4 - 20 mA	0 - 20 mA
		1 - 5 V	0 - 5 V
		2 - 10 V	0 - 10 V

## Operating Conditions

	Reference Conditions	Operative Limits	Transportation and Storage
<b>Ambient temperature</b>	20°C ± 2°C (68°F ± 4°F)	0°C to 55°C (32°F to 131°F)	-20°C to 80°C (-4°F to 176°F)
<b>Relative Humidity</b>	60 - 70 %	20 - 95 % non -condensing	
<b>Voltage</b>	90 - 264 Vac ± 1 %	90 - 264 Vac 20 - 50 Vac or 22 - 65 Vdc	
<b>Frequency</b>	50 Hz	50 - 60 Hz	
<b>Source resistance</b>	< 10 ohms for thermocouple	1000 ohms max for thermocouple	
<b>Lead resistance for RTD</b>	< 0.1 ohm/lead (PT100)	50 ohms per lead maximum balanced (PT100)	





## EXTERNAL DIMENSIONS AND PANEL CUTOUT

DCP100

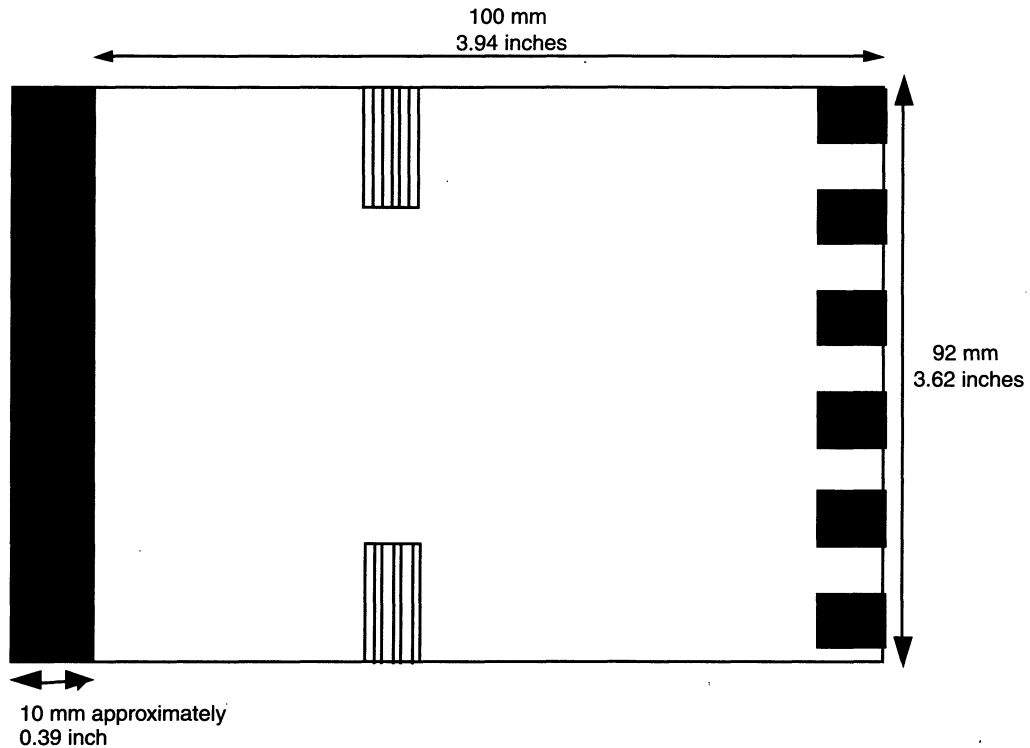
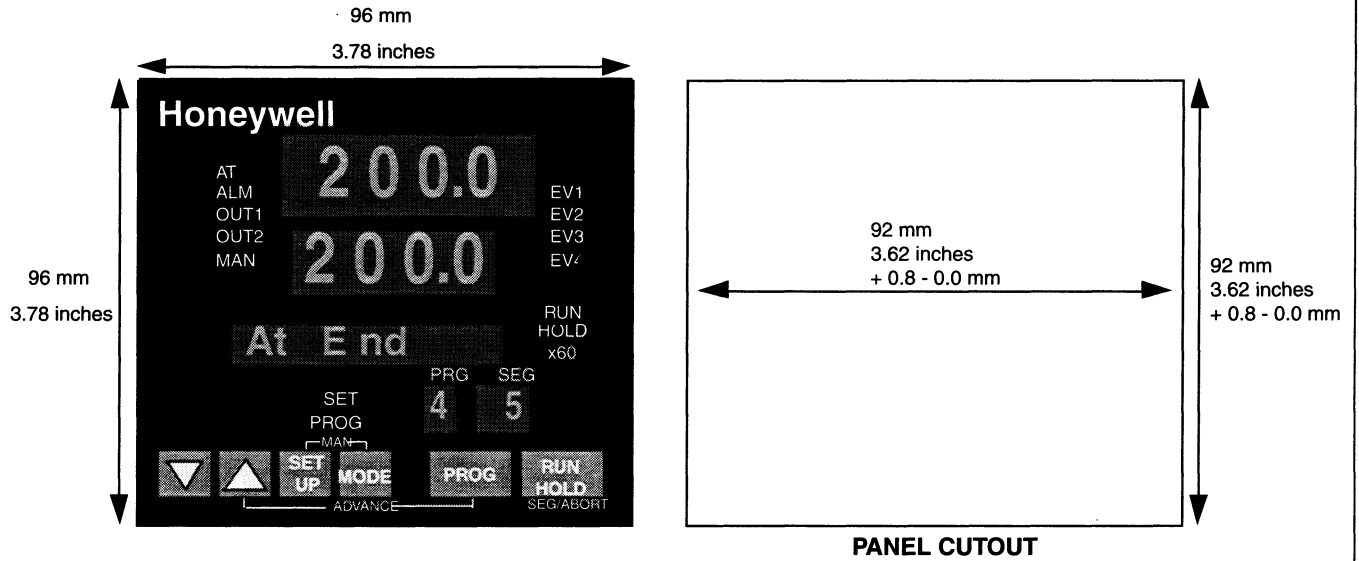

# WIRING DIAGRAMS

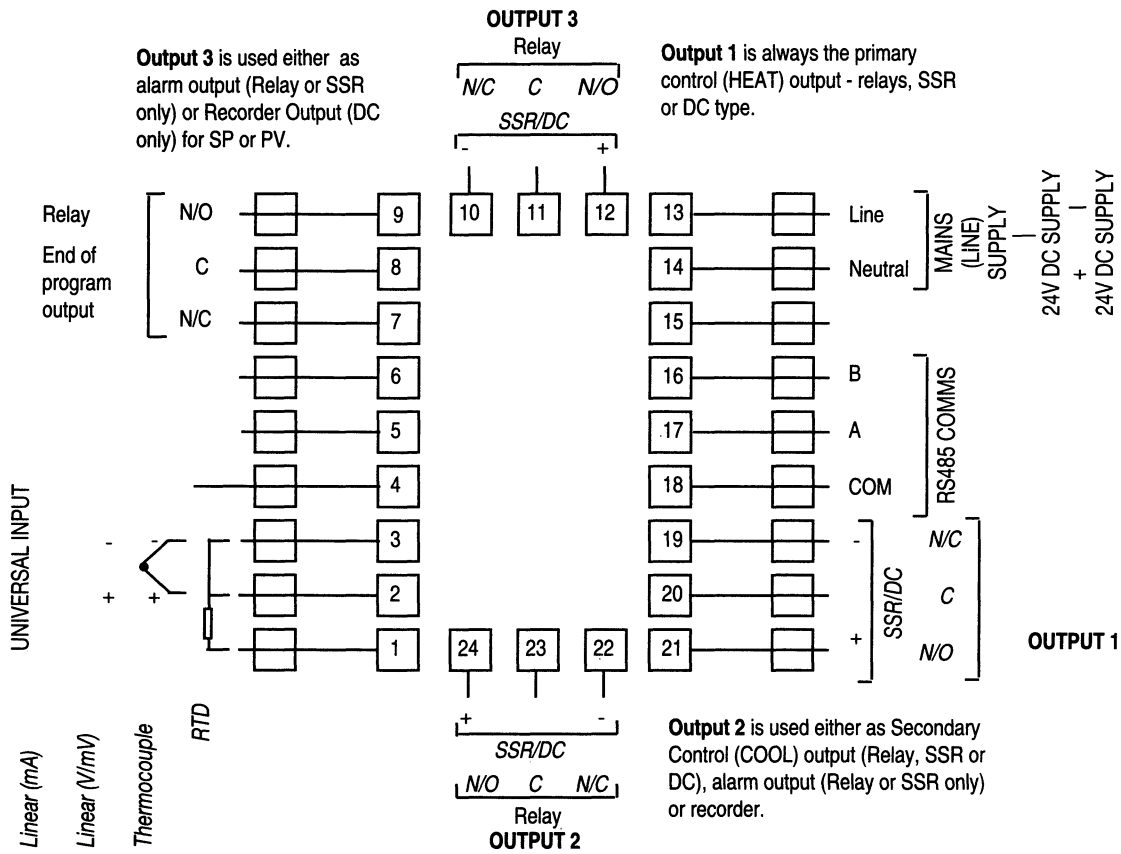

WIRING DIAGRAMS (continued)

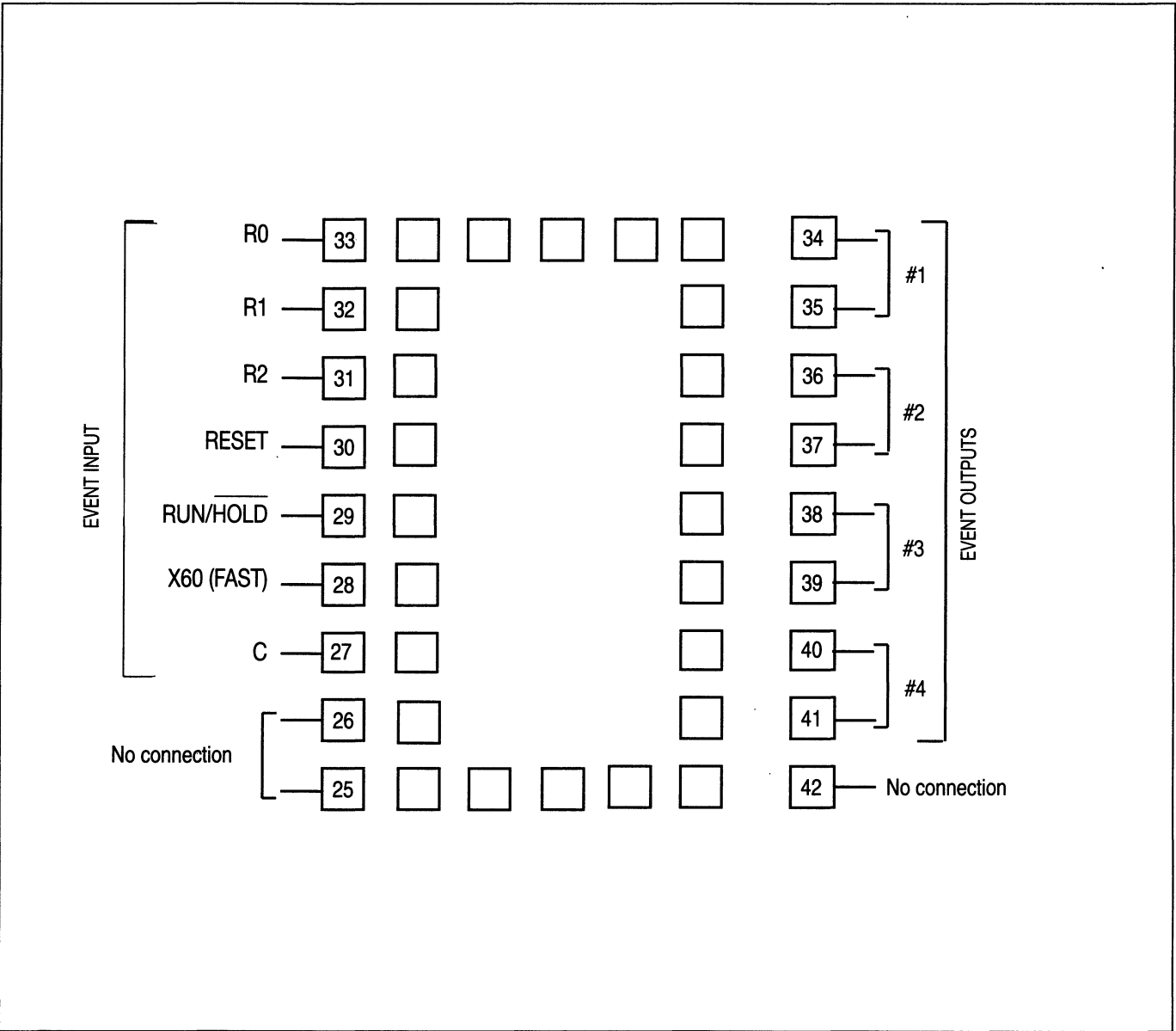

Distributor :

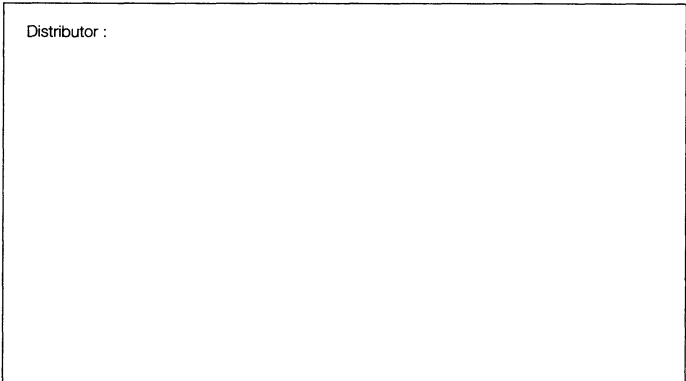

**Industrial Automation and Control**

*Helping You Control Your World*

Honeywell Inc.

In the U.S.A.: Honeywell Industrial Automation and Control, 16404 North Black Canyon Hwy., Phoenix, AZ 85023, (602) 313-5000

In Canada: The Honeywell Centre, 155 Gordon Baker Rd., North York, Ontario M2H 3N7, 1-800-461-0013

In Latin America: Honeywell Inc., 14505 Commerce Way, Suite 500, Miami Lakes, Florida 33016-1556, (305) 3642300

In Japan: Yamatake-Honeywell Co. Ltd. Nagai Int'l Bldg., 2-12-19 Shibuya, Shibuya-Ku, Tokyo 150, Japan, 81-3-3486-2051

In Asia: Honeywell Asia Pacific Inc., N° 19, Toa Payoh, Lorong 8 #06-00, Singapore 1231, 354-6768

Honeywell Pacific Division: Honeywell Pty Ltd., 5 Thomas Holt Drive, North Ryde Sydney, NSW Australia 2113, (61-2) 353 7000

In Europe: Honeywell S.A., Avenue du Bourget, 1140 Brussels, Belgium, (32) 2-728-2111

Honeywell Control System Ltd, Honeywell House, Bracknell, UK-RG 12 1 EB, (44) 1344 826000